

## PQxxxEH01ZxH Series

Low Voltage Operation  
Low Power-Loss Voltage Regulators

### ■ Features

1. Low voltage operation  
(Minimum operating voltage: 2.35V)  
2.5V input → available 1.5 to 1.8V output
2. Large output current type (I<sub>o</sub>: 1A)
3. Low dissipation current  
(Dissipation current at no load: MAX. 2mA  
Output OFF-state dissipation current: MAX. 5μA)
4. Low power-loss
5. Built-in overcurrent and overheat protection functions
6. TO-263 package
7. RoHS directive compliant

### ■ Applications

1. Peripheral equipment of personal computers
2. Power supplies for various electronic equipment such as DVD player or STB

### ■ Model Line-up

Output current (I <sub>o</sub> )	Package type	Output voltage (V <sub>o</sub> )		
		1.5V	1.8V	2.5V
1A	Taping	PQ015EH01ZPH	PQ018EH01ZPH	PQ025EH01ZPH
	Sleeve	PQ015EH01ZZH	PQ018EH01ZZH	PQ025EH01ZZH

### ■ Absolute Maximum Ratings

(T<sub>a</sub>=25°C)

Parameter	Symbol	Rating	Unit
*1 Input voltage	V <sub>IN</sub>	10	V
*1 Output control voltage	V <sub>C</sub>	10	V
Output current	I <sub>o</sub>	1	A
*2 Power dissipation	P <sub>D</sub>	35	W
*3 Junction temperature	T <sub>j</sub>	150	°C
Operating temperature	T <sub>opr</sub>	-40 to +85	°C
Storage temperature	T <sub>stg</sub>	-40 to +150	°C
Soldering temperature	T <sub>sol</sub>	260(10s)	°C

\*1 All are open except GND and applicable terminals.

\*2 P<sub>D</sub>: With infinite heat sink

\*3 Overheat protection may operate at T<sub>j</sub>: 125°C to 150°C

### ■ Outline Dimensions

(Unit : mm)

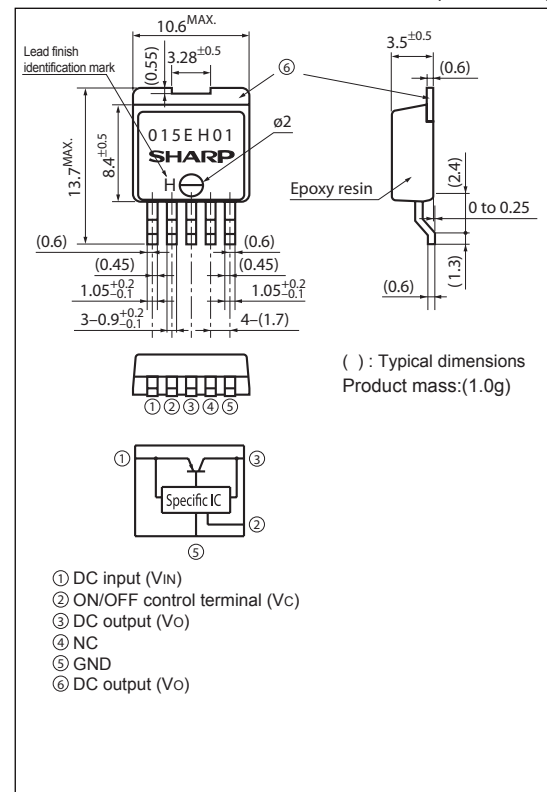

Lead finish: Lead-free solder plating  
(Composition: Sn2Cu)

Notice The content of data sheet is subject to change without prior notice.

In the absence of confirmation by device specification sheets, SHARP takes no responsibility for any defects that may occur in equipment using any SHARP devices shown in catalogs, data books, etc. Contact SHARP in order to obtain the latest device specification sheets before using any SHARP device.

### Electrical Characteristics

(Unless otherwise specified, condition shall be  $V_{IN}=V_O(TYP)+1V$ ,  $I_o=0.5A$ ,  $V_c=2.7V$ ,  $T_a=25^\circ C$ )

Parameter	Symbol	Conditions	MIN.	TYP.	MAX.	Unit
Input voltage	$V_{IN}$	-	Refer to below table			V
Output voltage	$V_O$	-	Refer to below table			V
Load regulation	RegL	$I_o=5mA$ to 1A	-	0.2	2.0	%
Line regulation	Regl	$V_{IN}=V_O(TYP)+1V$ to $V_O(TYP)+6V$ , $I_o=5mA$	-	0.1	1.0	%
Temperature coefficient of output voltage	$TcV_O$	$T_j=0$ to $+125^\circ C$ , $I_o=5mA$	-	$\pm 0.01$	-	%/ $^\circ C$
Ripple rejection	RR	Refer to Fig.2	45	60	-	dB
*4 ON-state voltage for control	$V_{C(ON)}$	-	2.0	-	-	V
ON-state current for control	$I_{C(ON)}$	-	-	-	200	$\mu A$
OFF-state voltage for control	$V_{C(OFF)}$	-	-	-	0.8	V
OFF-state current for control	$I_{C(OFF)}$	$V_c=0.4V$	-	-	2	$\mu A$
Quiescent current	$I_q$	$I_o=0A$	-	1	2	mA
Output OFF-state consumption current	$I_{qs}$	$I_o=0A$ , $V_c=0.4V$	-	-	5	$\mu A$

\*4 In case of opening control terminal ②, output voltage turns off

### Input voltage range

Model No.	Symbol	Conditions	MIN.	TYP.	MAX.	Unit
PQ015EH01ZxH	$V_{IN}$	$I_o=0.5A$ , $V_c=2.7V$ , $T_a=25^\circ C$	2.35	-	10	V
PQ018EH01ZxH			2.35	-	10	
PQ025EH01ZxH			3.0	-	10	

### Output voltage

Model No.	Symbol	Conditions	MIN.	TYP.	MAX.	Unit
PQ015EH01ZxH	$V_O$	$V_{IN}=V_O(TYP)+1V$ , $I_o=0.5A$ , $V_c=2.7V$ , $T_a=25^\circ C$	1.45	1.5	1.55	V
PQ018EH01ZxH			1.75	1.8	1.85	
PQ025EH01ZxH			2.438	2.5	2.562	

Fig.1 Test Circuit

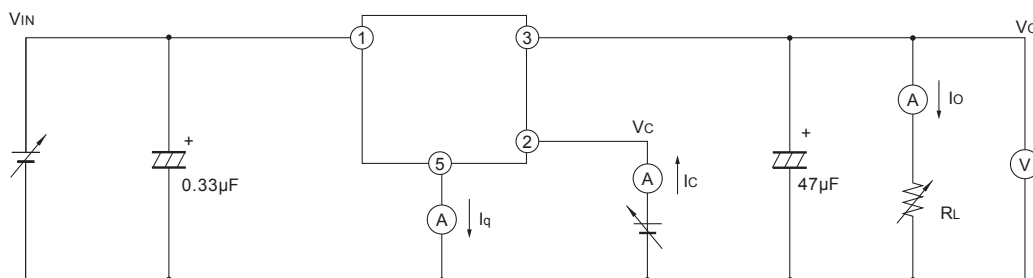

Fig.2 Test Circuit for Ripple Rejection

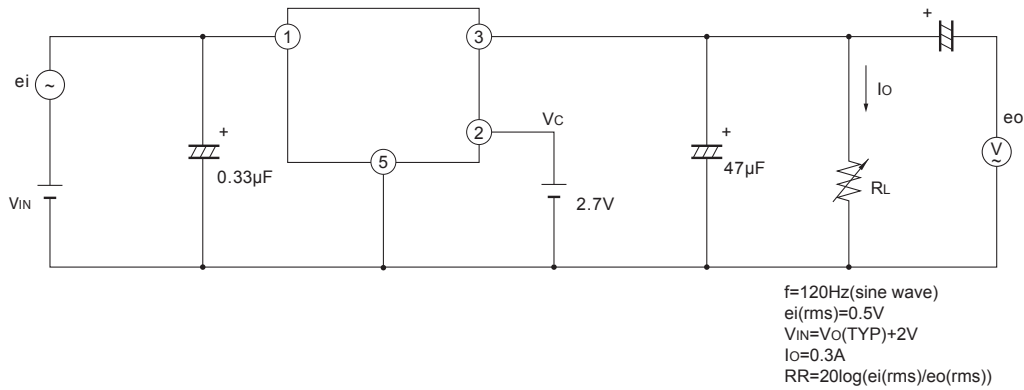

Fig.3 Power Dissipation vs. Ambient Temperature

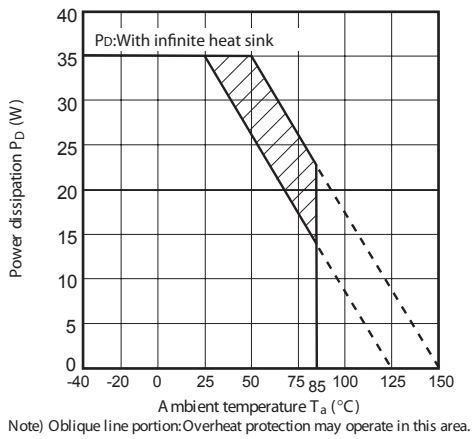

Fig.4 Overcurrent Protection Characteristics (Typical Value) (PQ015EH01ZxH)

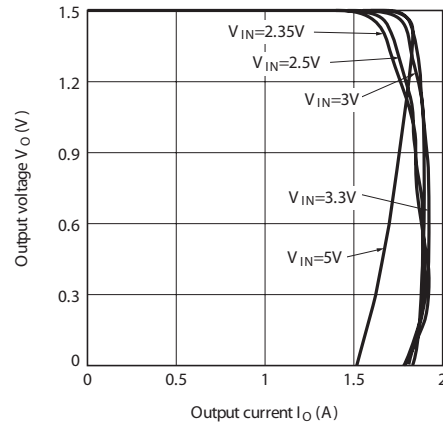

Fig.5 Overcurrent Protection Characteristics (Typical Value) (PQ018EH01ZxH)

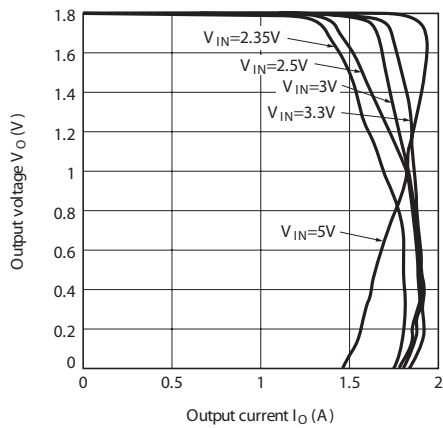

Fig.6 Overcurrent Protection Characteristics (Typical Value) (PQ025EH01ZxH)

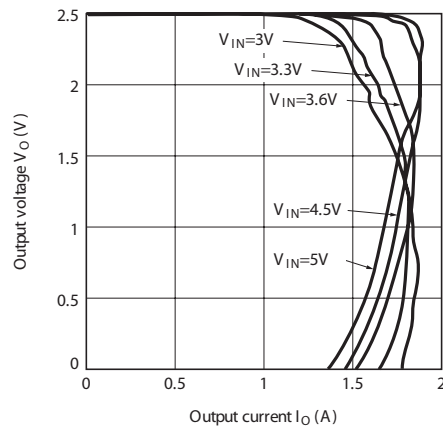

Fig.7 Output Voltage vs. Ambient Temperature (PQ015EH01ZxH)

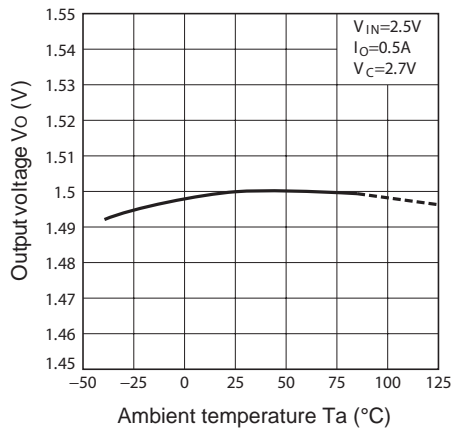

Fig.8 Output Voltage vs. Ambient Temperature (PQ018EH01ZxH)

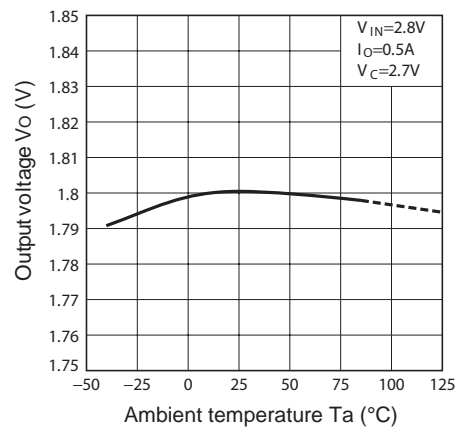

Fig.9 Output Voltage vs. Ambient Temperature (PQ025EH01ZxH)

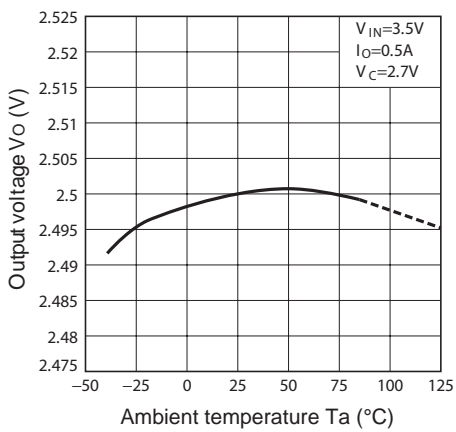

Fig.10 Output Voltage vs. Input Voltage (PQ015EH01ZxH)

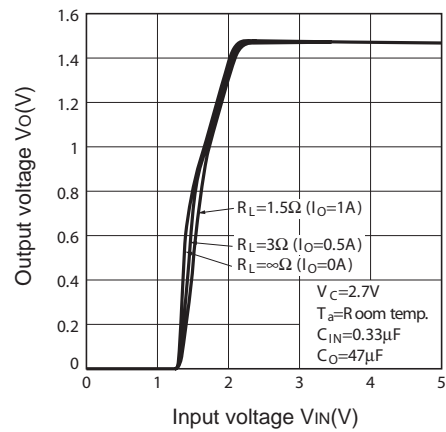

Fig.11 Output Voltage vs. Input Voltage (PQ018EH01ZxH)

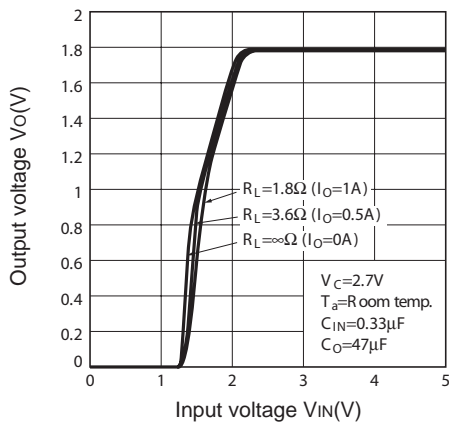

Fig.12 Output Voltage vs. Input Voltage (PQ025EH01ZxH)

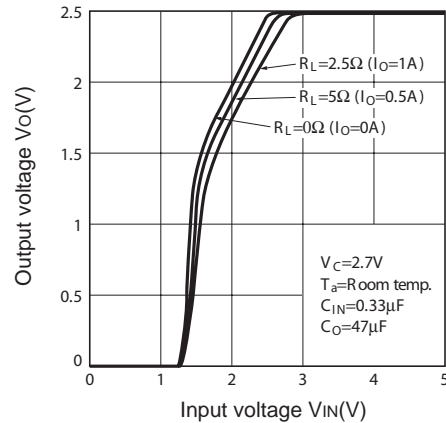

Fig.13 Circuit Operating Current vs. Input Voltage (PQ015EH01ZxH)

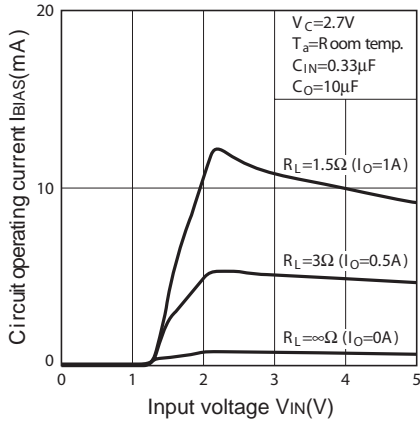

Fig.14 Circuit Operating Current vs. Input Voltage (PQ018EH01ZxH)

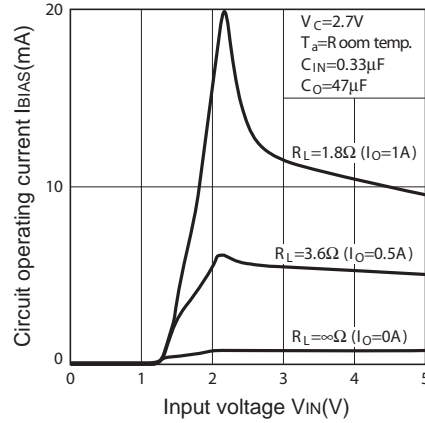

Fig.15 Circuit Operating Current vs. Input Voltage (PQ025EH01ZxH)

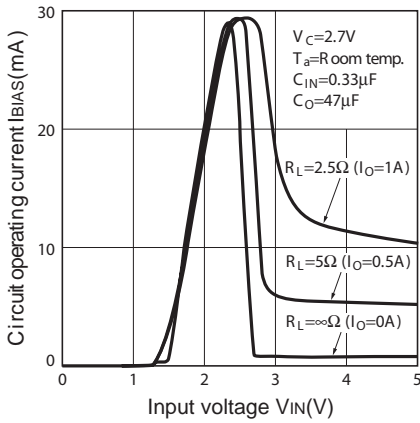

Fig.16 Quiescent Current vs. Junction Temperature

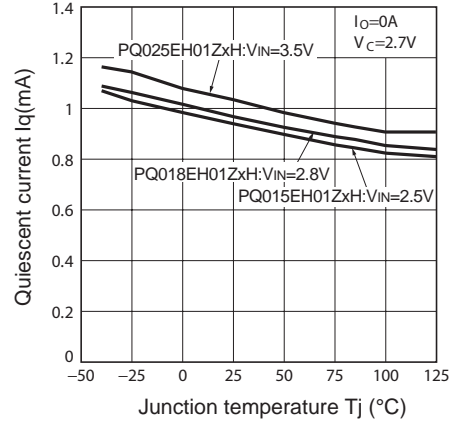

Fig.17 ON-OFF Threshold Voltage vs. Ambient Temperature (PQ018EH01ZxH)

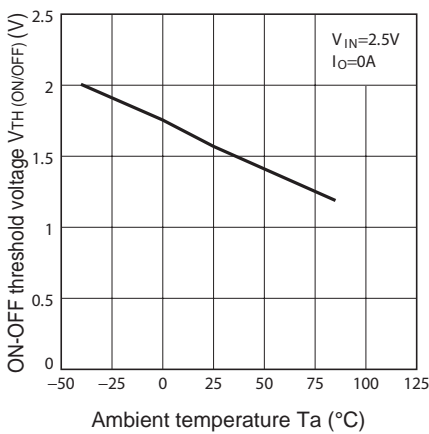

Fig.18 Ripple Rejection vs. Input Ripple Frequency

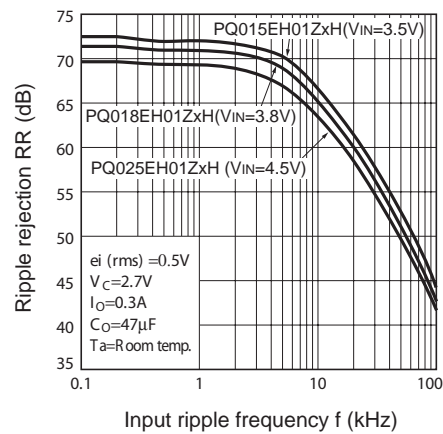

Fig.19 Ripple Rejection vs. Output Current

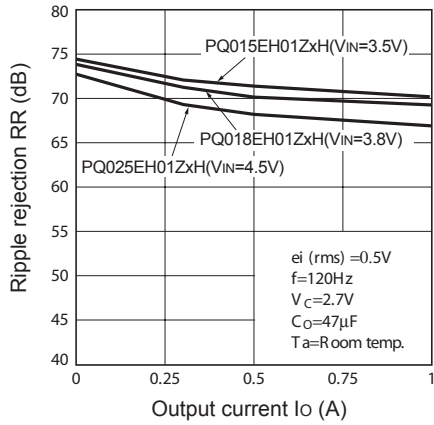
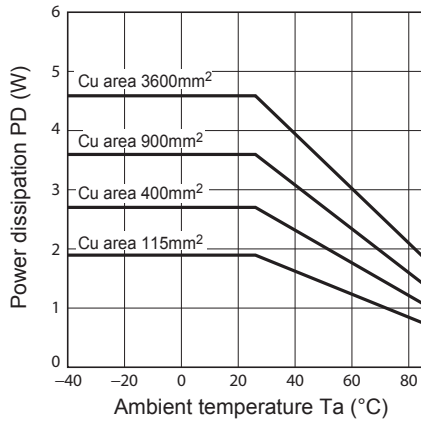
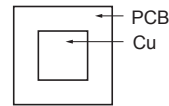

Fig.20 Power Dissipation vs. Ambient Temperature (Typical Value)



Mounting PCB



Material : Glass-cloth epoxy resin  
 Size : 60×60×1.6mm  
 Cu thickness : 65 $\mu$ m

Fig.21 Typical Application

